

## Contact insert - HC-B 6-I-CT-M - 1648157

Please be informed that the data shown in this PDF Document is generated from our Online Catalog. Please find the complete data in the user's documentation. Our General Terms of Use for Downloads are valid (<http://phoenixcontact.com/download>)



HEAVYCON male insert, B6 series, 6-pos., for crimp contacts

### Your advantages

- For fast coding with plastic profile



### Key Commercial Data

Packing unit	1 pc
GTIN	 4 046356 092272
GTIN	4046356092272
Weight per Piece (excluding packing)	47.350 g
Custom tariff number	85366990
Country of origin	China

### Technical data

#### General

Note	For HEAVYCON ADVANCE and HEAVYCON housing of B6 type, crimp contacts CK 2,5-ED (crimp contacts not included in the scope of supply). Connectors may be operated only when there is no load/voltage.
Connection method	Crimp connection
Number of connections per position	1
Degree of pollution	3
Overvoltage category	III
Number of positions	6+PE
Insertion/withdrawal cycles	≥ 500

# Contact insert - HC-B 6-I-CT-M - 1648157

## Technical data

### General

Size	B6
Contact numbering	1 - 6
Conductor cross section	0.5 mm <sup>2</sup> ... 4 mm <sup>2</sup>
Connection cross section AWG	20 ... 12
Stripping length of the individual wire	7.5 mm
Assembly instructions	To ensure correct use, installation in housing with IP54 protection or better is required
Connection	For housing type B6. Connectors may only be inserted when there is no load/the power is switched off. Use a screwdriver to remove the crimp contacts. The opening for the screwdriver is next to the opening where the conductor is inserted.

### Ambient conditions

Degree of protection (IP)	IP20
Ambient temperature (operation)	-40 °C ... 125 °C (including heating up of contacts)

### Material data

Contact material	Copper alloy
Contact surface material	Ag (alternatively Au)
Contact carrier material	PA
Standards/regulations	PA: Fire protection in rail vehicles - requirement sets R22 and R23 acc. to DIN EN 45545-2 (Risk level HL1 - HL2)
	PA: Fire protection in rail vehicles - requirement set R24 acc. to DIN EN 45545-2 (Risk level HL1 - HL3)

### Electrical characteristics

Rated voltage (III/3)	500 V
Rated surge voltage	6 kV
Rated current	16 A

### Standards and Regulations

Connection in acc. with standard	CSA
Constructional and testing regulations	DIN EN 61984
	DIN EN 60664
	IEC 60352
Flammability rating according to UL 94	V0

### Environmental Product Compliance

China RoHS	Environmentally friendly use period: unlimited = EFUP-e
	No hazardous substances above threshold values

## Drawings

# Contact insert - HC-B 6-I-CT-M - 1648157

Schematic diagram

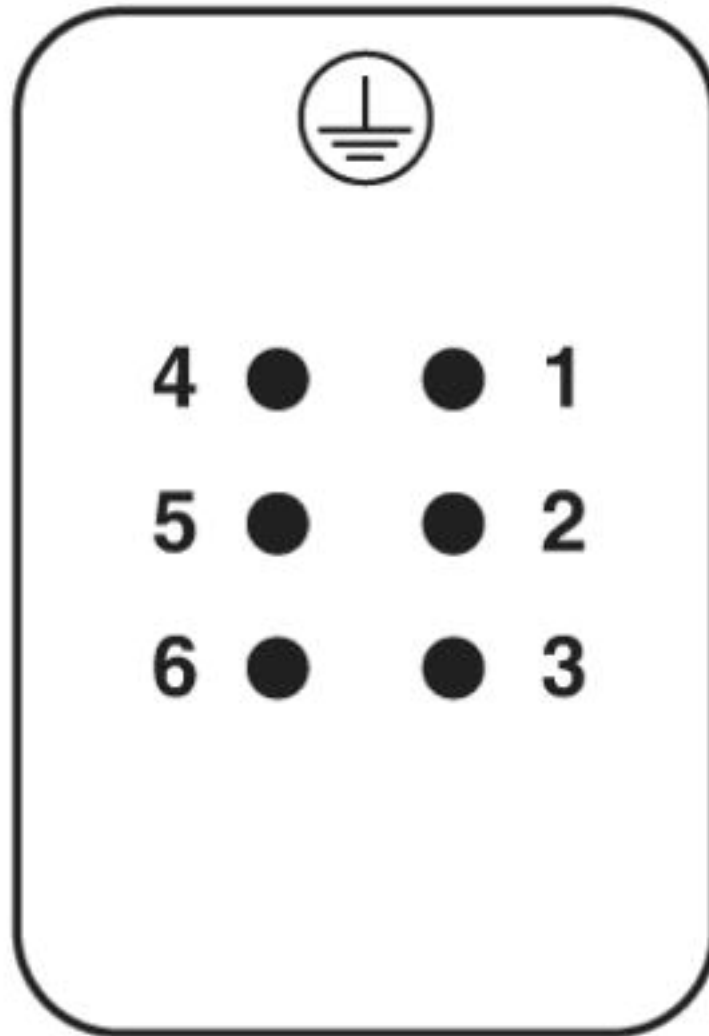

Connector pin assignment, connection side

# Contact insert - HC-B 6-I-CT-M - 1648157

Diagram

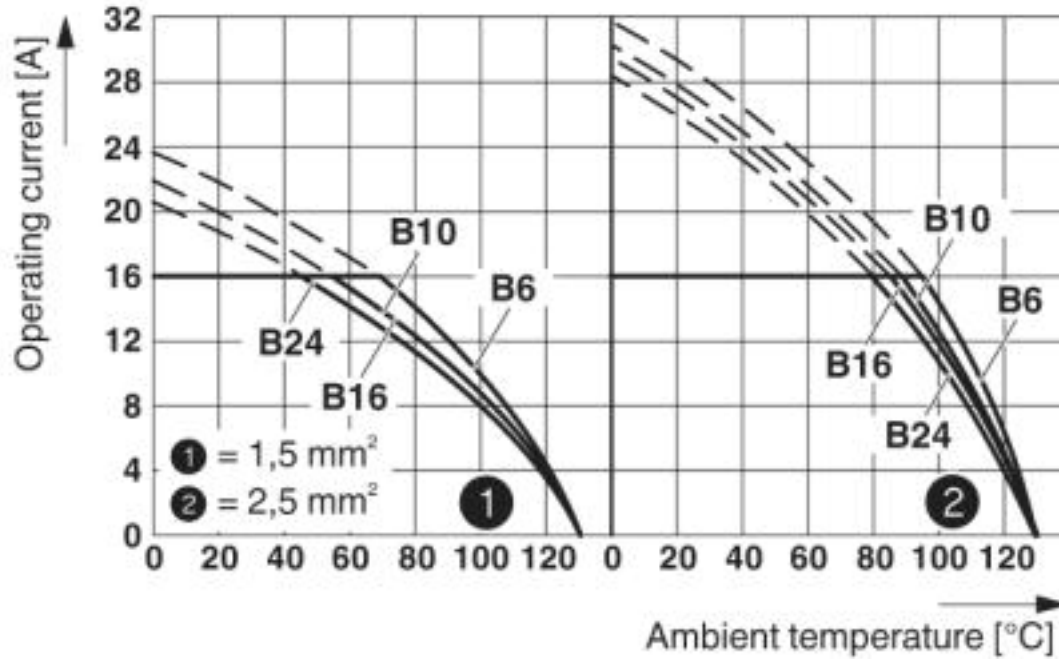

Derating diagram

Dimensional drawing

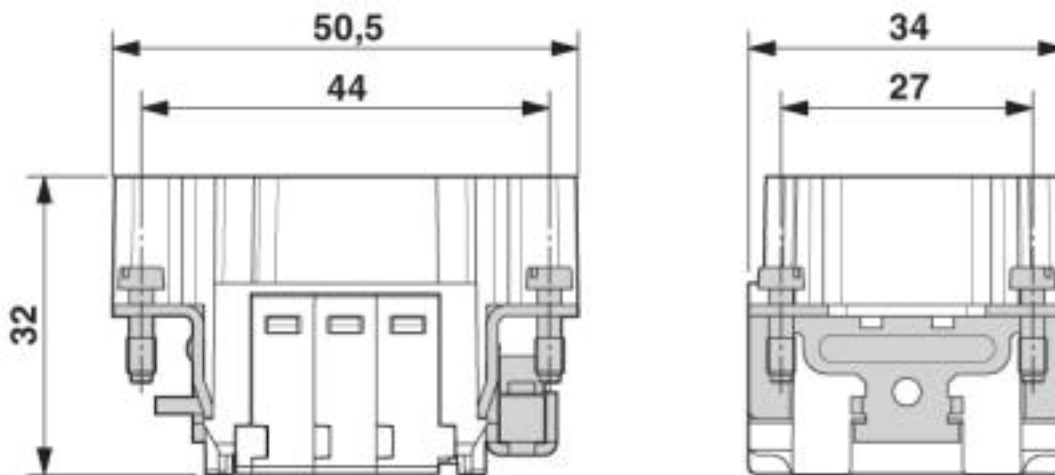

Male insert

# Contact insert - HC-B 6-I-CT-M - 1648157

Dimensional drawing

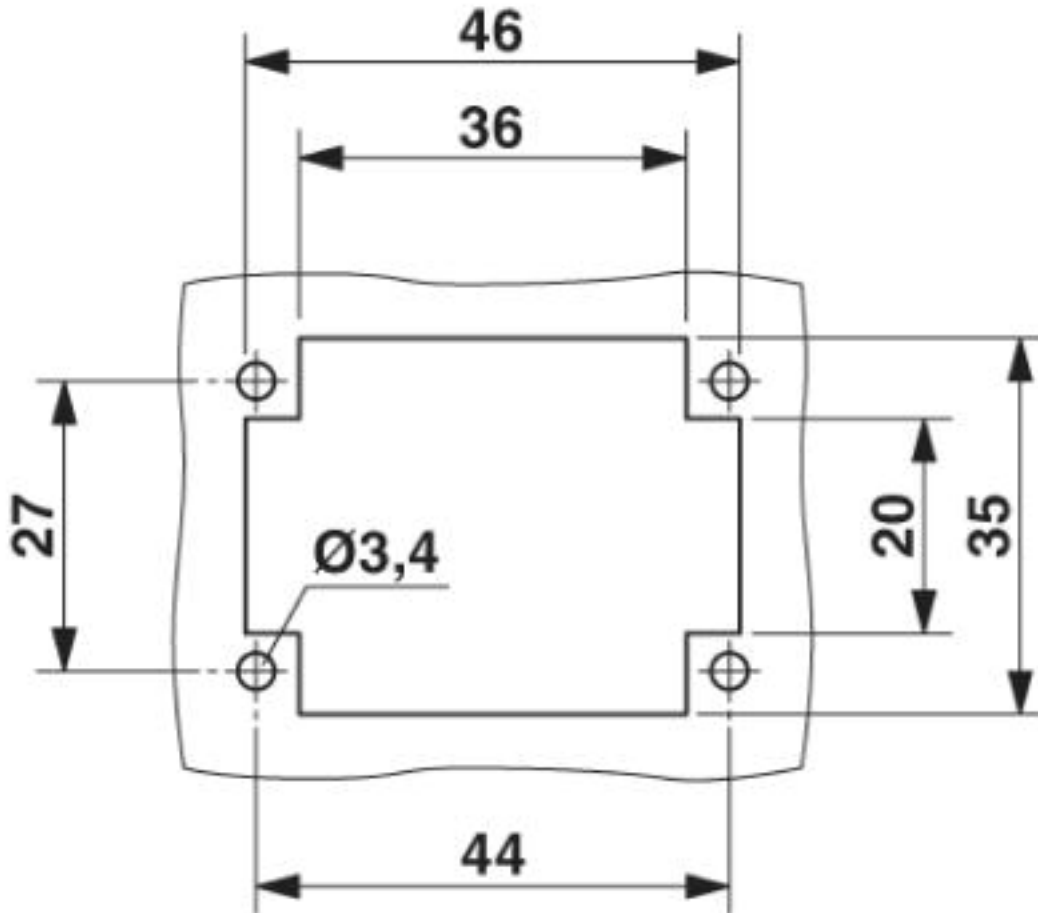

Mounting cutout when used without housing

# Contact insert - HC-B 6-I-CT-M - 1648157

Dimensional drawing

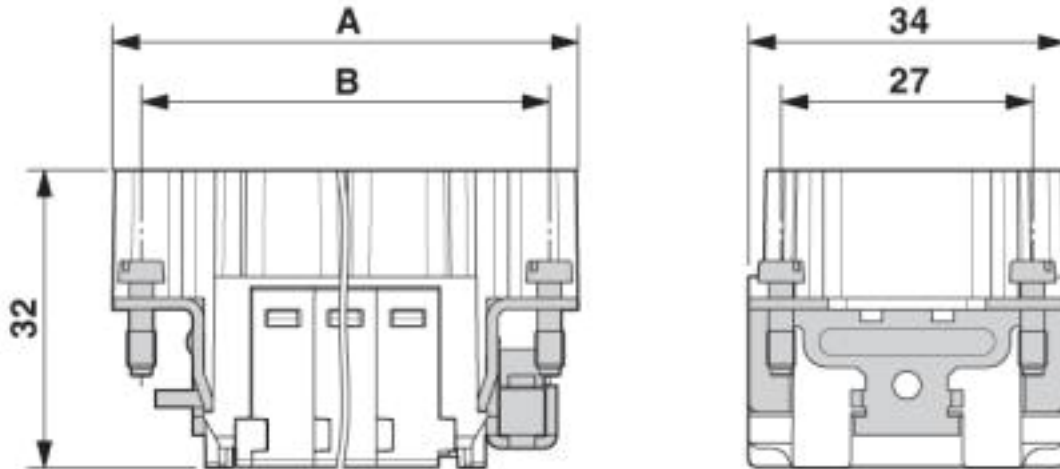

## Classifications

### eCl@ss

eCl@ss 4.0	27140800
eCl@ss 4.1	27140800
eCl@ss 5.0	27143400
eCl@ss 5.1	27261200
eCl@ss 6.0	27261200
eCl@ss 7.0	27440205
eCl@ss 8.0	27440205
eCl@ss 9.0	27440205

### ETIM

ETIM 2.0	EC000438
ETIM 3.0	EC000438
ETIM 4.0	EC000438
ETIM 5.0	EC000438
ETIM 6.0	EC000438
ETIM 7.0	EC000438

### UNSPSC

UNSPSC 6.01	30211923
UNSPSC 7.0901	39121522
UNSPSC 11	39121522
UNSPSC 12.01	39121522
UNSPSC 13.2	39121522

# Contact insert - HC-B 6-I-CT-M - 1648157

## Approvals

### Approvals

#### Approvals

CSA / UL Recognized / cUL Recognized / EAC / cULus Recognized

#### Ex Approvals

### Approval details

CSA		<a href="http://www.csagroup.org/services-industries/product-listing/">http://www.csagroup.org/services-industries/product-listing/</a>	013631_6233_01
Nominal voltage UN		600 V	
Nominal current IN		20 A	
mm <sup>2</sup> /AWG/kcmil		20-12	

UL Recognized		<a href="http://database.ul.com/cgi-bin/XYV/template/LISEXT/1FRAME/index.htm">http://database.ul.com/cgi-bin/XYV/template/LISEXT/1FRAME/index.htm</a>	FILE E 118976
Nominal voltage UN		600 V	
Nominal current IN		13 A	
mm <sup>2</sup> /AWG/kcmil		22-14	

cUL Recognized		<a href="http://database.ul.com/cgi-bin/XYV/template/LISEXT/1FRAME/index.htm">http://database.ul.com/cgi-bin/XYV/template/LISEXT/1FRAME/index.htm</a>	FILE E 118976
Nominal voltage UN		600 V	
Nominal current IN		13 A	
mm <sup>2</sup> /AWG/kcmil		22-14	

EAC		RU C- DE.AI30.B.01102
-----	---	--------------------------

## Contact insert - HC-B 6-I-CT-M - 1648157

### Approvals

cULus Recognized



### Accessories

#### Accessories

##### Adapter plate

Adapter plate - HC-B 24-ADP-B 6-GY - 1660407



HEAVYCON adapter plate, type B24 on B6, for panel cutouts of type B24, gray

### Coding element

Coding profile - CP-HC - 1686478



Coding profile, 4 coding profiles per strip, for insertion in coding keyways

Coding element - HC-CBU - 1676860



Coding socket for coding up to 16 connectors

Coding bolt - HC-CB - 1772722



Coding pin, prevents mismatching of up to six connectors with an identical number of positions

## Contact insert - HC-B 6-I-CT-M - 1648157

### Accessories

Coding element - HC-CST - 1676857



Coding peg for coding up to 16 connectors

---

### Crimp contact

Crimp contact - CK2,5-ED-0,50ST AG - 1663572



Turned 2.5 crimp contact, individual male contact, core diameter 0.5 mm<sup>2</sup>, silver-plated

---

Crimp contact - CK2,5-ED-0,75ST AG - 1663585



Turned 2.5 crimp contact, individual male contact, core diameter 0.75 mm<sup>2</sup>, silver-plated

---

Crimp contact - CK2,5-ED-1,00ST AG - 1663598



Turned 2.5 crimp contact, individual male contact, core diameter 0.75 to 1.00 mm<sup>2</sup>, silver-plated

---

Crimp contact - CK2,5-ED-1,50ST AG - 1663608



Turned 2.5 crimp contact, individual male contact, core diameter 1.5 mm<sup>2</sup>, silver-plated

---

## Contact insert - HC-B 6-I-CT-M - 1648157

### Accessories

Crimp contact - CK2,5-ED-2,50ST AG - 1663611



Turned 2.5 crimp contact, individual male contact, core diameter 2.5 mm<sup>2</sup>, silver-plated

---

Crimp contact - CK2,5-ED-3,00ST AG - 1663624



Turned 2.5 crimp contact, individual male contact, core diameter 3.00 mm<sup>2</sup>, silver-plated

---

Crimp contact - CK2,5-ED-4,00ST AG - 1663637



Turned 2.5 crimp contact, individual male contact, core diameter 4.00 mm<sup>2</sup>, silver-plated

---

Crimp contact - CK2,5-ED-0,50ST AU - 1674804



Turned 2.5 crimp contact, individual male contact, core diameter 0.5 mm<sup>2</sup>, gold-plated

---

Crimp contact - CK2,5-ED-1,00ST AU - 1674781



Turned 2.5 crimp contact, individual male contact, core diameter 0.75 to 1.0 mm<sup>2</sup>, gold-plated

---

## Contact insert - HC-B 6-I-CT-M - 1648157

### Accessories

Crimp contact - CK2,5-ED-1,50ST AU - 1674778



Turned 2.5 crimp contact, individual male contact, core diameter 1.5 mm<sup>2</sup>, gold-plated

---

Crimp contact - CK2,5-ED-2,50ST AU - 1674817



Turned 2.5 crimp contact, individual male contact, core diameter 2.5 mm<sup>2</sup>, gold-plated

---

Crimp contact - CK2,5-ED-4,00ST AU - 1674794



Turned 2.5 crimp contact, individual male contact, core diameter 4.00 mm<sup>2</sup>, gold-plated

---

### Crimping tool

Crimping pliers - CRIMPFOX-1,6/2,5-ED-4,0 - 1687419



Crimping pliers, for turned contacts, CK 1.6 ED... and CK 2.5 ED...

---

### DIN rail mounting frame

DIN rail mounting frame - HC-SMR-2B 6 - 1687998



HEAVYCON DIN rail mounting frame, for two contact inserts of type B6

## Contact insert - HC-B 6-I-CT-M - 1648157

### Accessories

---

DIN rail mounting frame - HC-SMR-B 6 - 1687956



HEAVYCON DIN rail mounting frame, for type B6 contact inserts

---

### Docking frame

Docking frames - HC-B 6-ANDOCK - 1586112



Docking frames for racks, for type B6 contact inserts, with 4 M5 flat headed screws, slide-in offset for x/y axis of  $\pm 1.5$  mm

---

### Mounting material

Screw - HC-B-PES - 1604997



PE screw, for contact inserts HC-B / HC-BB / HC-DD / HC-D40 / HC-D64

---

PE multiplier - HC-B-3PE - 1644326



PE multiplier, for three PE connections, for HC-B (besides HC-B..E..ZZ) / HC-BB / HC-DD / HC-D40 / HC-D64 contact inserts

---

## Contact insert - HC-B 6-I-CT-M - 1648157

### Accessories

Strain relief clamp - HC-B-ZG - 1685327



Strain relief clamps contact inserts of series: B-, BB-, D 40, D 64, DD and HV, straight cable exit

---

Strain relief clamp - HC-B-ZS - 1685330



Strain relief clamps contact inserts of series: B-, BB-, D 40, D 64, DD and HV, lateral cable exit

---

### Plug mounting plate

DIN rail mounting frame - HC-SMP 125-B 6-AML - 1660957



HEAVYCON DIN rail mounting frame with panel mounting base with single locking latch, for contact inserts of type B6

---

### Additional products

Contact insert - HC-B 6-I-CT-F - 1648160



HEAVYCON female insert, B6 series, 6-pos., for crimp contacts

---